

# FUSE BLOCK — JUNCTION BOX (J/B)

Terminal Arrangement/Sedan

## Terminal Arrangement/Sedan

NJEL0148

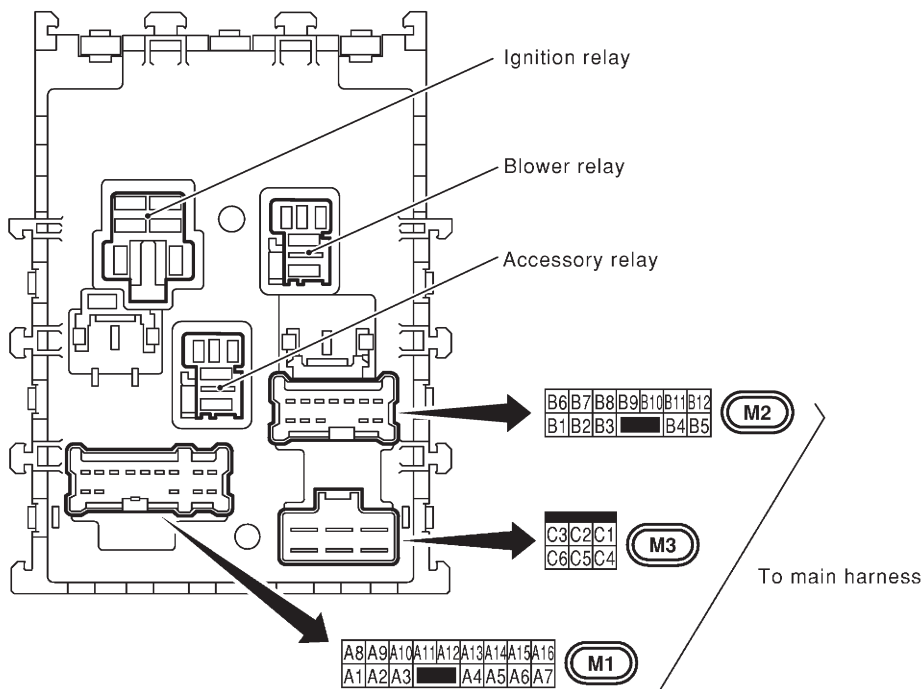
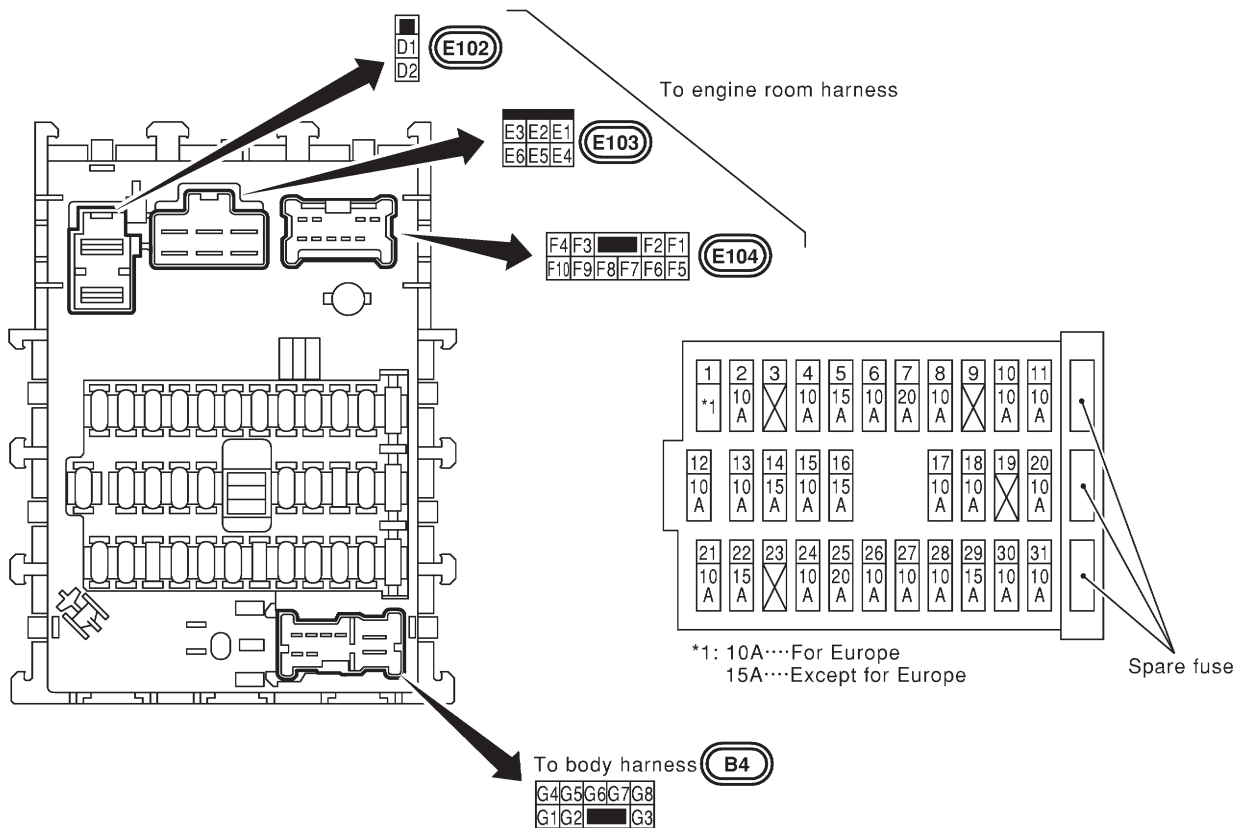

# FUSE BLOCK — JUNCTION BOX (J/B)

Terminal Arrangement/Hatchback

## Terminal Arrangement/Hatchback

NJEL0493

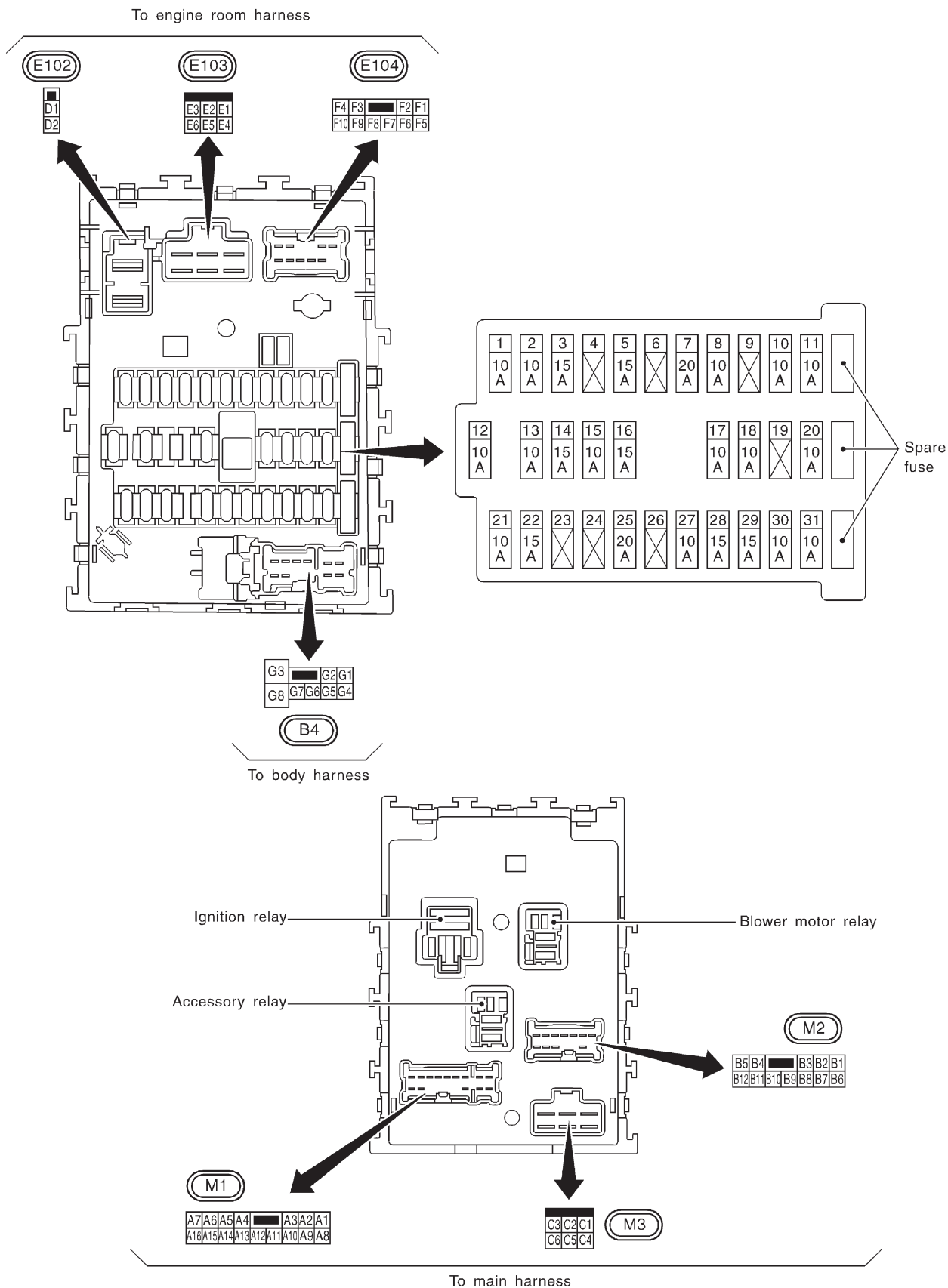

MEL938L

# FUSE AND FUSIBLE LINK BOX

Terminal Arrangement/Sedan

## Terminal Arrangement/Sedan

NJEL0149

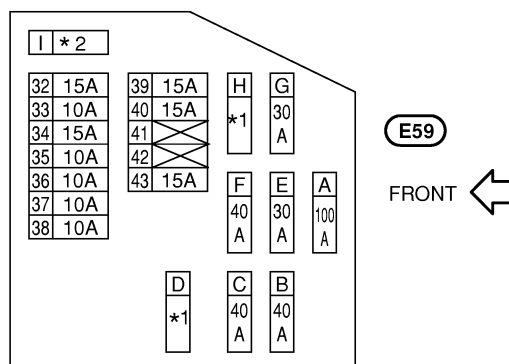

(Except for Europe: A/T models with QG15DE•16DE•18DE engine)  
 (For Europe: With daytime light system)

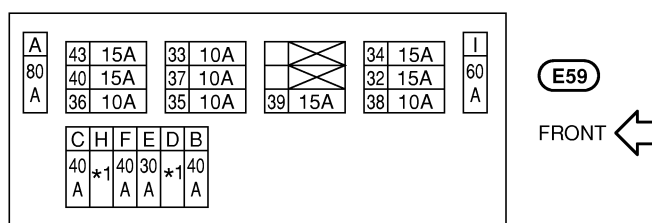

(Except for Europe: A/T models with QG13DE engine and M/T models with QG engine)  
 (For Europe: Without daytime light system)

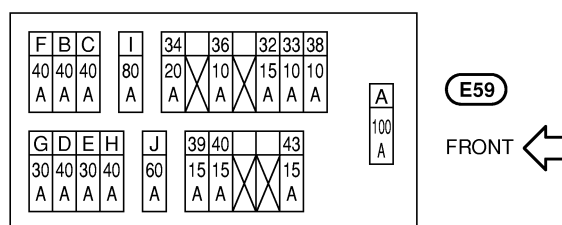

(YD engine)

- \* 1 : 30A ... For Europe
- 40A ... Except for Europe
- \* 2 : 80A ... For Europe
- 60A ... Except for Europe

# FUSE AND FUSIBLE LINK BOX

Terminal Arrangement/Hatchback

## Terminal Arrangement/Hatchback

NJEL0494

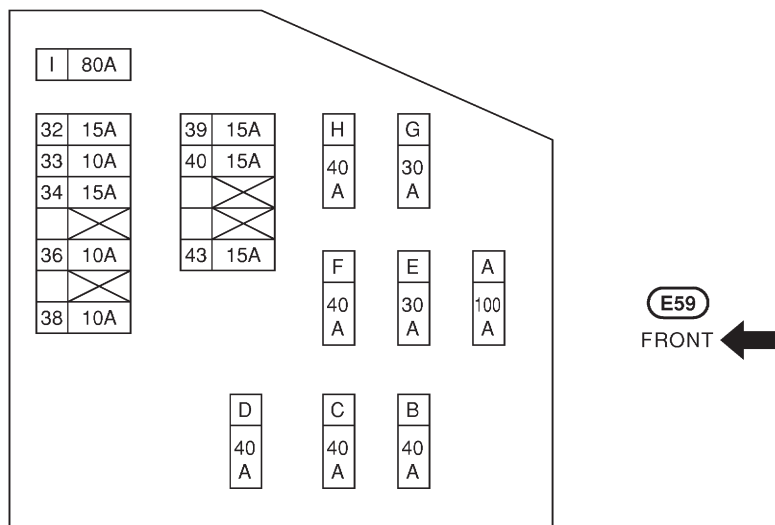

(QG engine models with daytime light system)

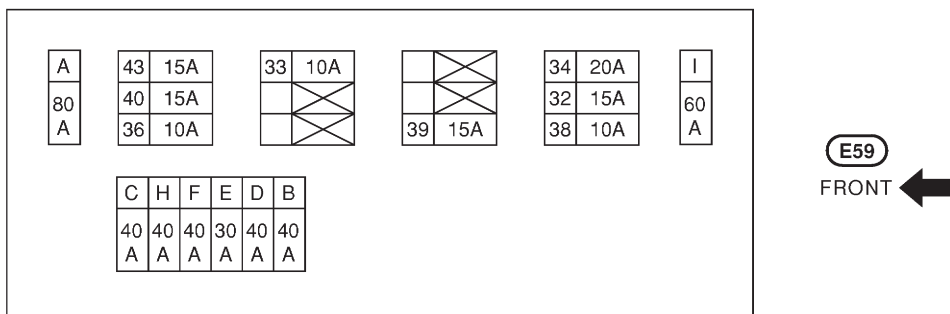

(QG engine models without daytime light system)

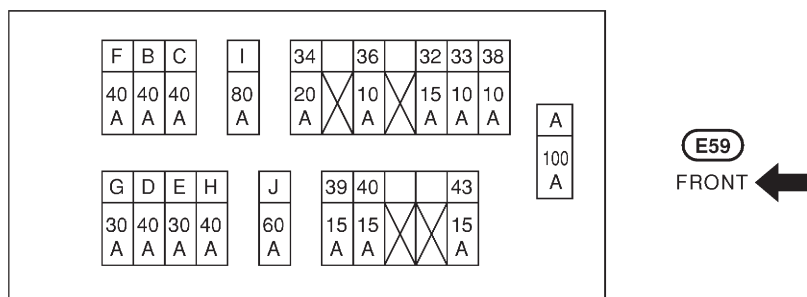

(YD engine)

# ELECTRICAL UNITS

Terminal Arrangement/Sedan

## Terminal Arrangement/Sedan

NJEL0150

ECM (QG engine)

F56

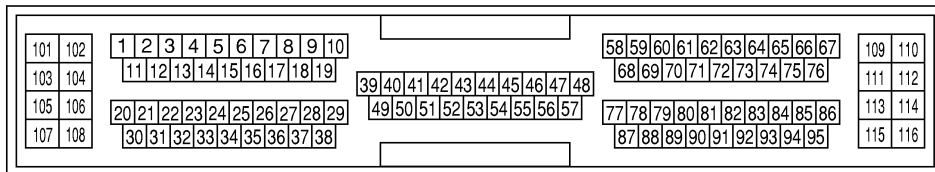

ECM (YD engine)

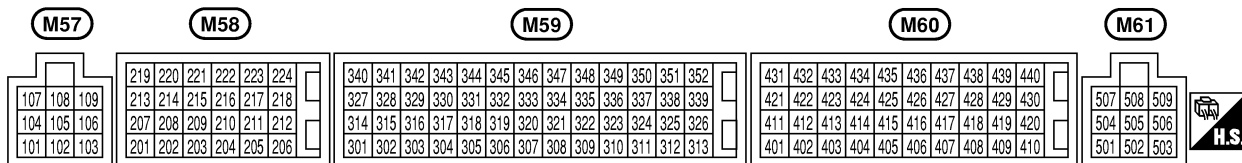

TCM (TRANSMISSION CONTROL MODULE)

F109

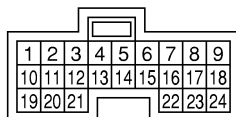

(White)

F110

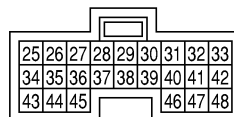

(Gray)

ABS ACTUATOR AND ELECTRIC UNIT

E1

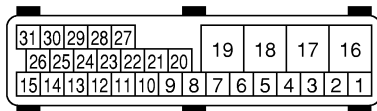

TIME CONTROL UNIT

M106

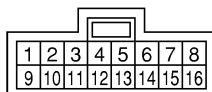

(Gray)

M107

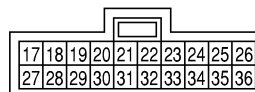

(Gray)

MULTI-REMOTE CONTROL UNIT

M77

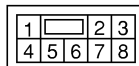

(Brown)

NAVI CONTROL UNIT

M95

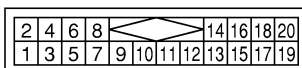

(White)

M96

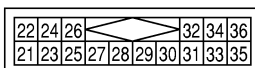

(White)

M97

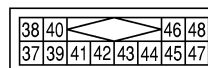

(Gray)

M305



# ELECTRICAL UNITS

Terminal Arrangement/Hatchback

## Terminal Arrangement/Hatchback

NJEL0495

ECM (F56) (QG engine)

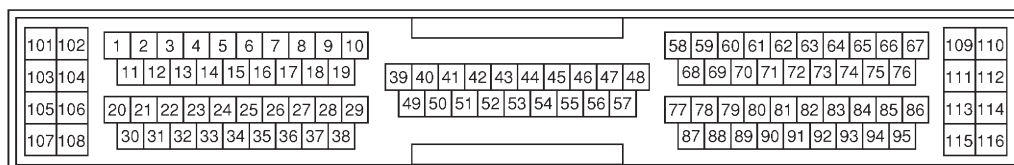

ECM (YD engine)

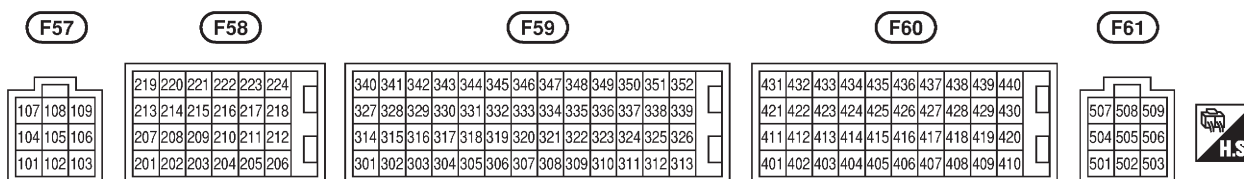

TCM (TRANSMISSION CONTROL MODULE)

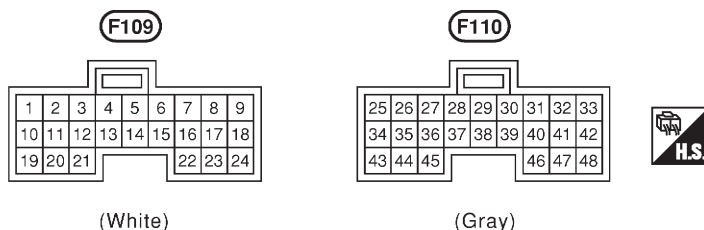

(White)

(Gray)

ABS ACTUATOR AND ELECTRIC UNIT (E1)

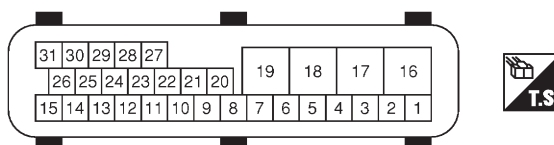

TIME CONTROL UNIT

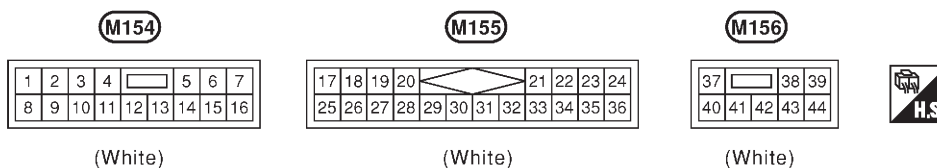

(White)

(White)

(White)

# JOINT CONNECTOR (J/C)

Terminal Arrangement/Sedan

## Terminal Arrangement/Sedan

NJEL0160

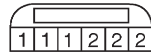

(White)

J/C-1 **F52**

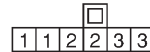

(Sky blue)

J/C-2 **M68**

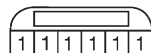

(Gray)

J/C-3 **F53**

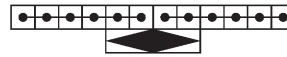

(Blue)

J/C-4 **M54**

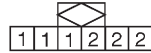
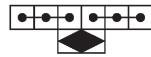

(White)

J/C-5 **F55**

# JOINT CONNECTOR (J/C)

Terminal Arrangement/Hatchback

## Terminal Arrangement/Hatchback

NJEL0496



J/C-3 (F53)

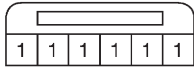

(Gray)



J/C-4 (F54)

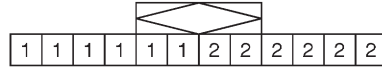

(Blue)



J/C-5 (F55)

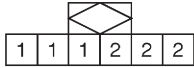

(White)

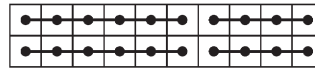

J/C-6 (F114)

